

# gala

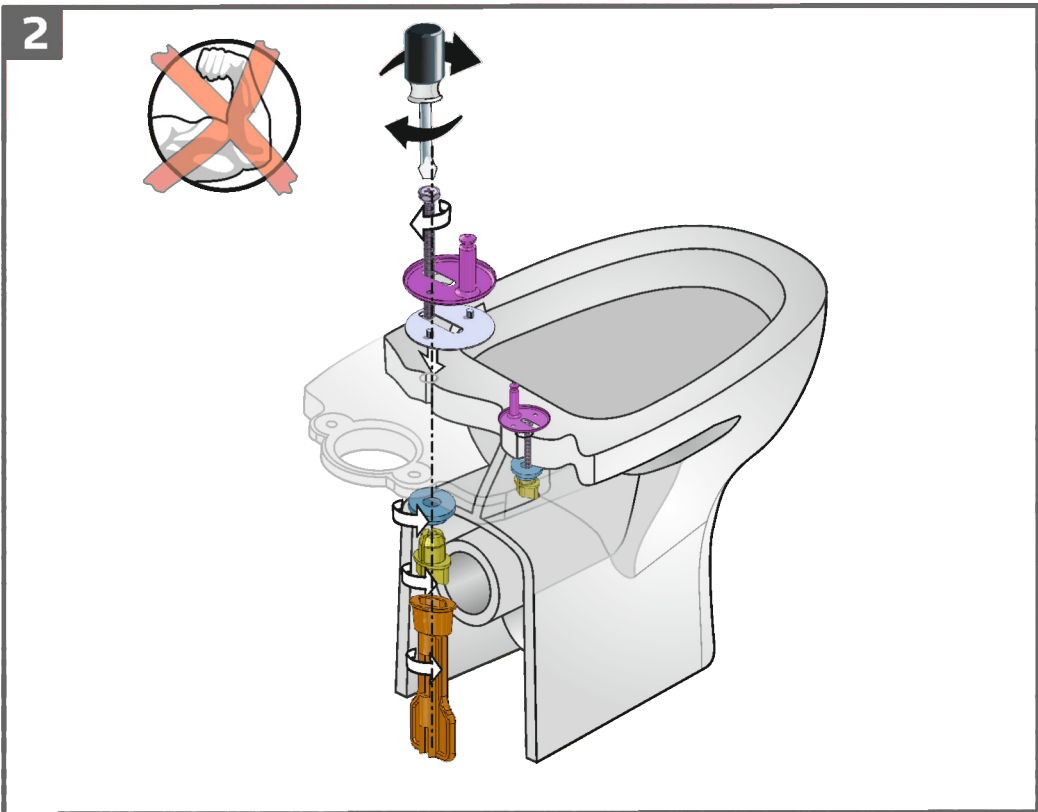
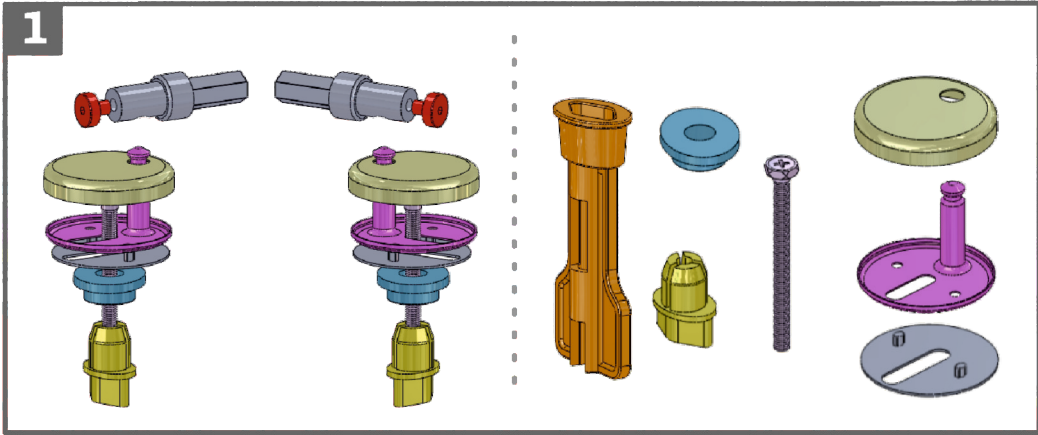
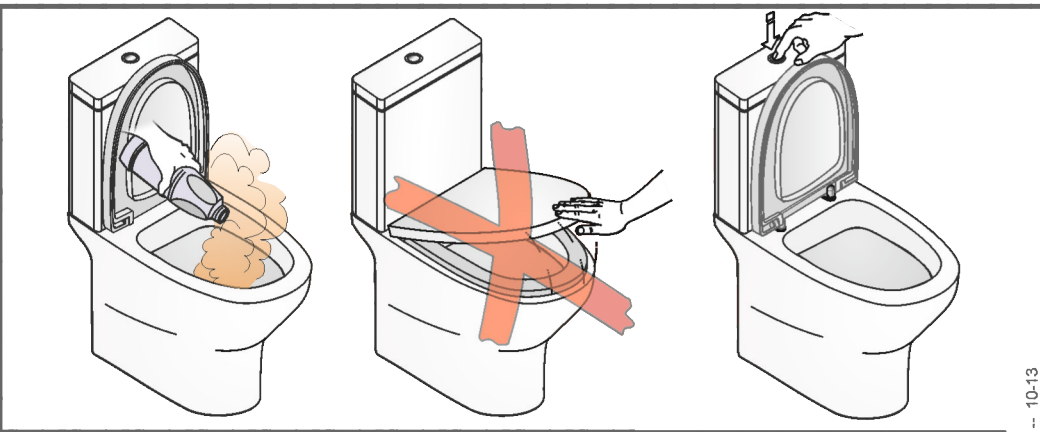
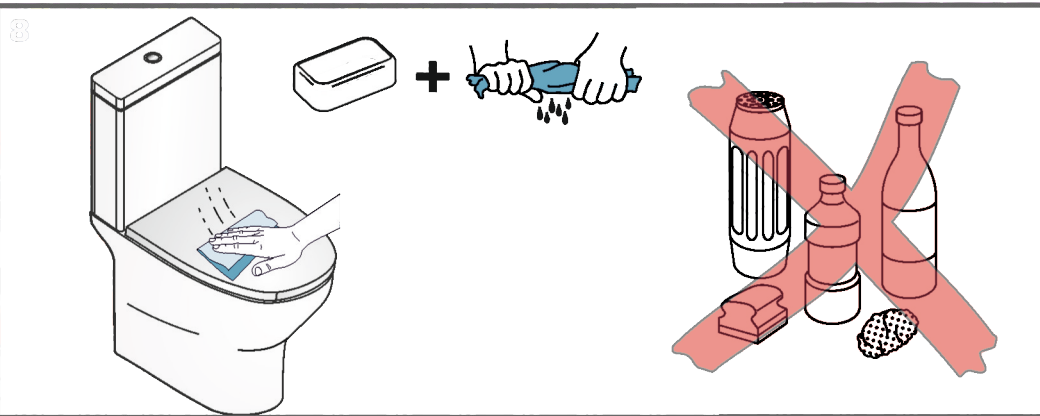

**Cerámicas Gala, S.A.**

Ctra. Madrid - Irún, Km. 244 - Apartado de Correos, 293 - 09080 BURGOS - ESPAÑA  
 Teléf. 947 474 100 Fax. 947 474 103 E\_mail: general@gala.es www.gala.es

Las medidas e información son a título orientativo y susceptibles de modificación sin previo aviso. Este documento anula los anteriores.  
 All information and sizes should be considered merely approximate and are subject to modification without notice. This document cancels the former ones.  
 Les cotes et informations sont à titre indicatif et peuvent subir des modifications sans avis préalable. Le document annule les précédents.

GDRW-861200208 a -- 10-13



3

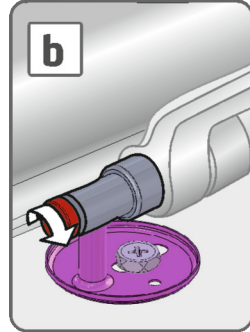
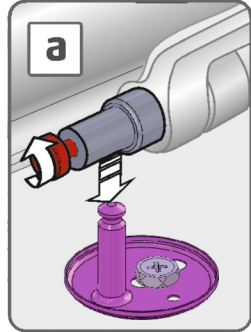

4

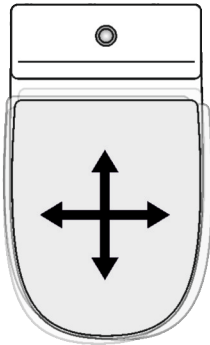
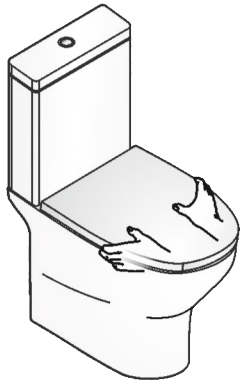

5

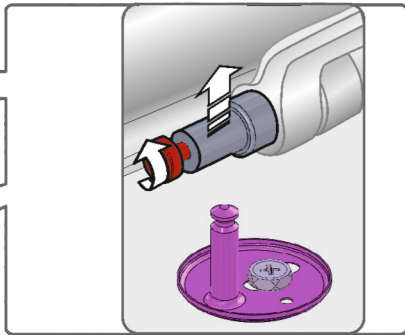
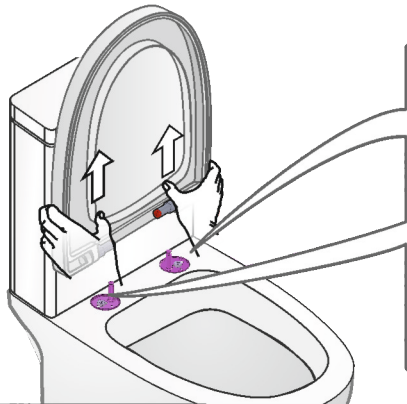

6

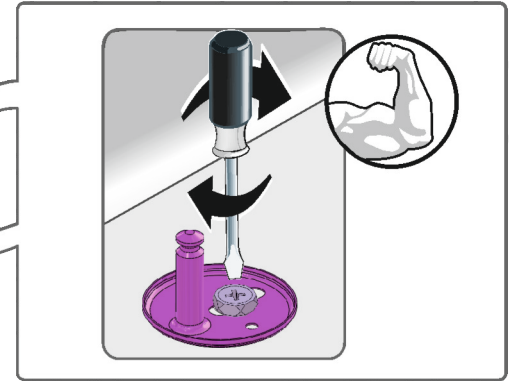
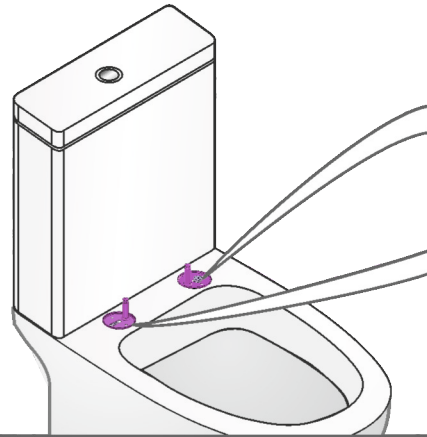

7

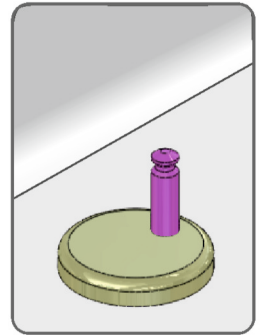
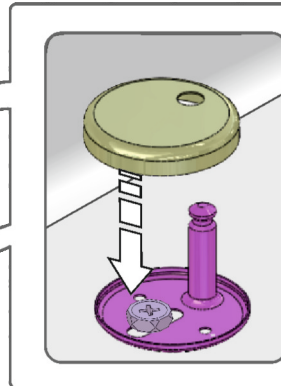
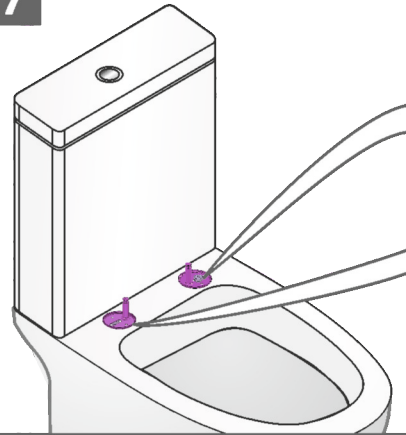

8

